

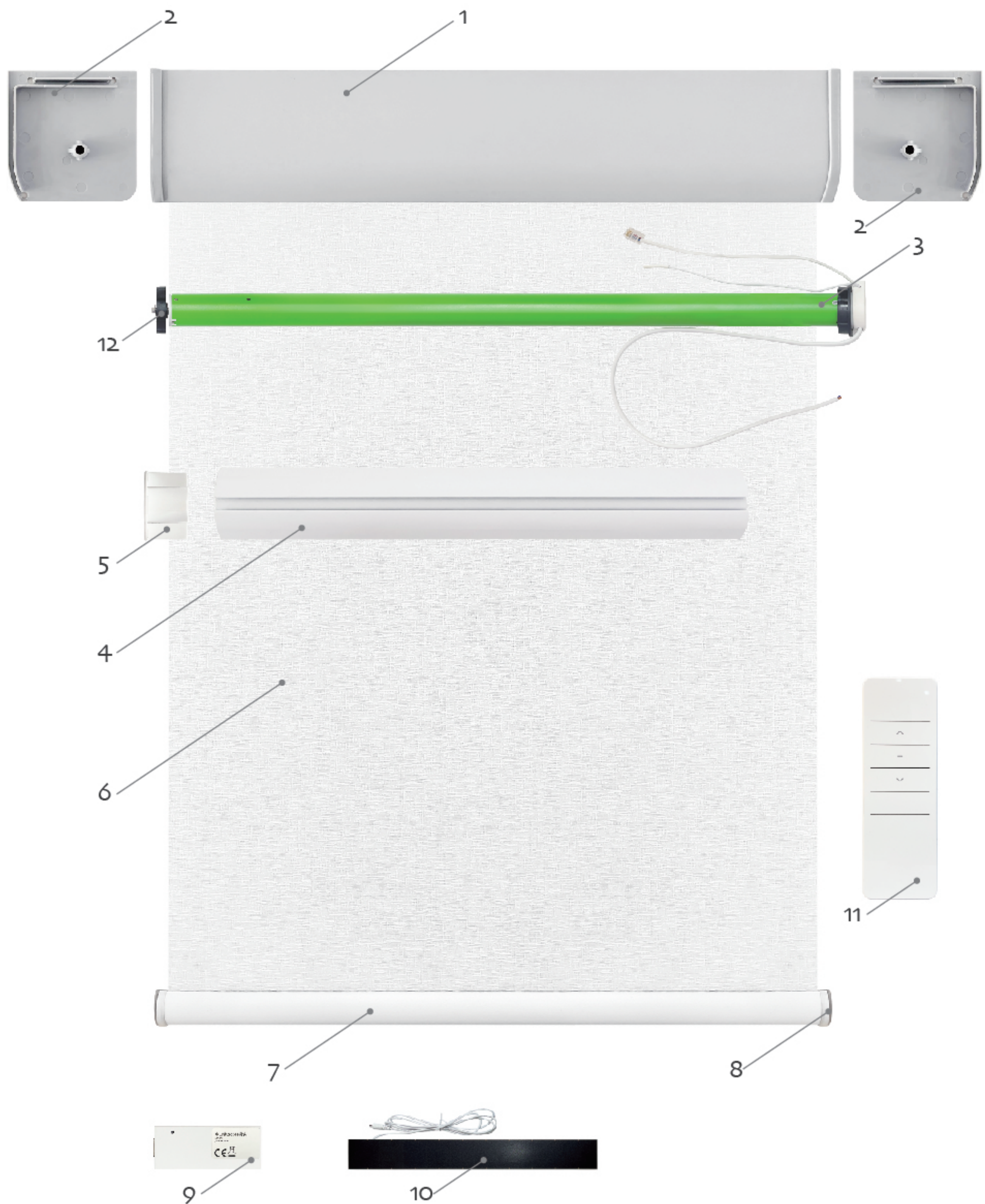

Installation & Usage Instruction
Motorized Roller Blinds Series

DESIGN BY HUNTERS

Product Structure



1. Cassette

2. Caps

3. Motor

4. Tube

5. Stopper

6. Fabric

7. Bottom rail

8. Bottom rail caps

9. Tuya/Zigbee controller

10. Solar board

11. Remote

12. Wheel

Packing list



Finished Roller Blinds x1



Bracket x2



Expansion screws x4



Instruction x1

Recommended installation tools



Mark Pen



Tap measure



Drill



Screw driver



Level instrument



Cable drilling tool



Rubber hammer



Electric hand drill

Installation Methods



Ceiling Mount



Side Wall Mount

Installing Steps

Step 1: Make sure the wall material such as wooden, concrete or brick etc. Measure the distance of mounting brackets and mark the point of mounting. Advise the point around 60-70mm from side wall.

Step 2: If the wall is wooden then could use the drill fix the screws. If the wall is in concrete or brick-concrete, then need use cable drilling tool make hole firstly then put into the expansion with rubber hammer.

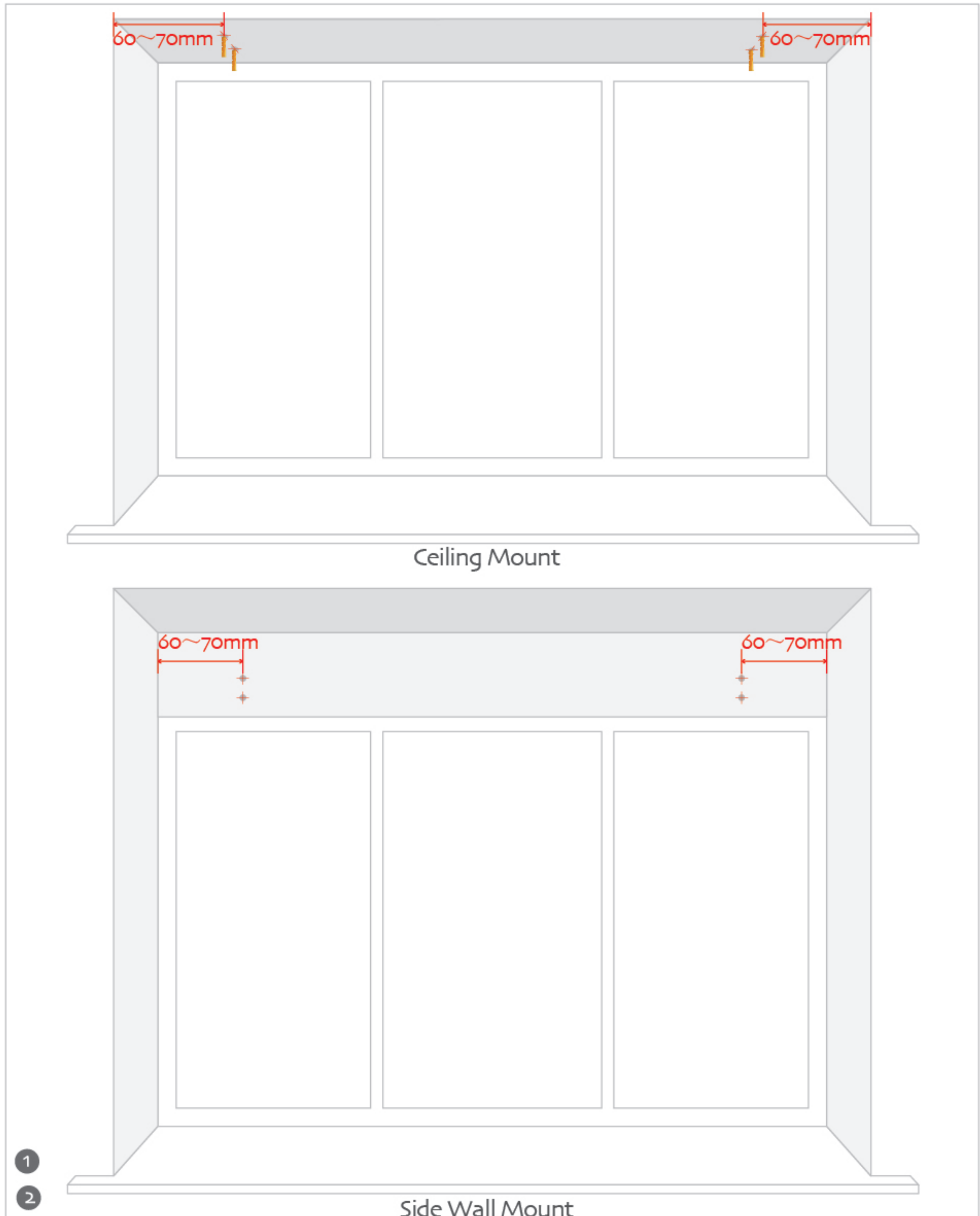

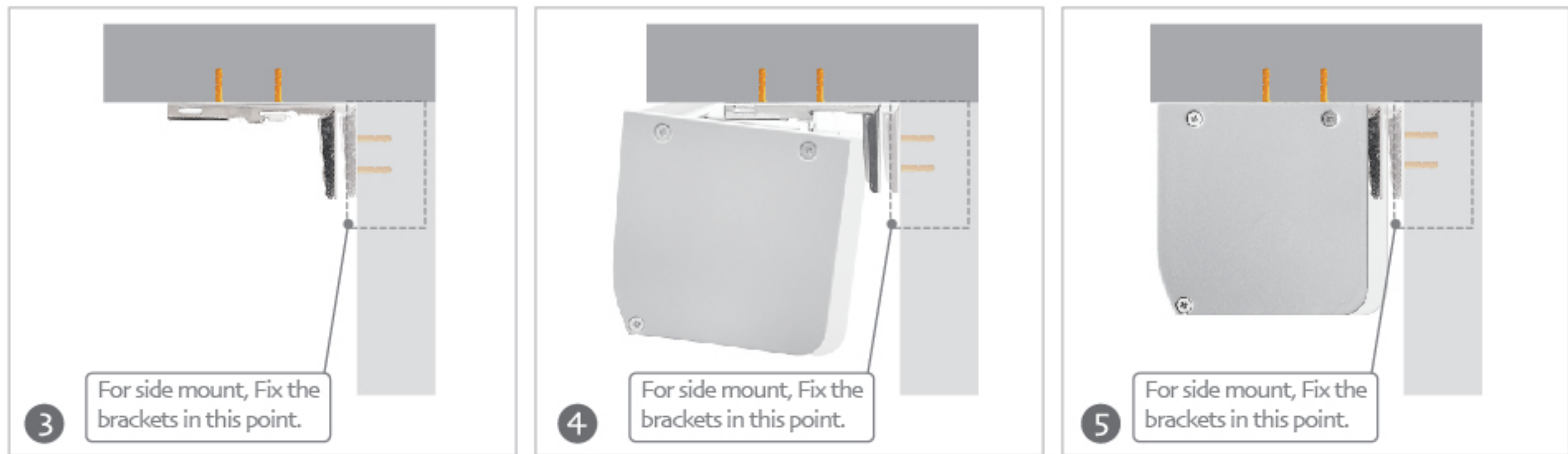

Step 3: Fix the mounting brackets with screws.

Step 4: Put the roller blinds hang into the brackets as pic.

Step 5: Push the top of cassette and you hear sound of click then the brackets inserted into the top of cassette.

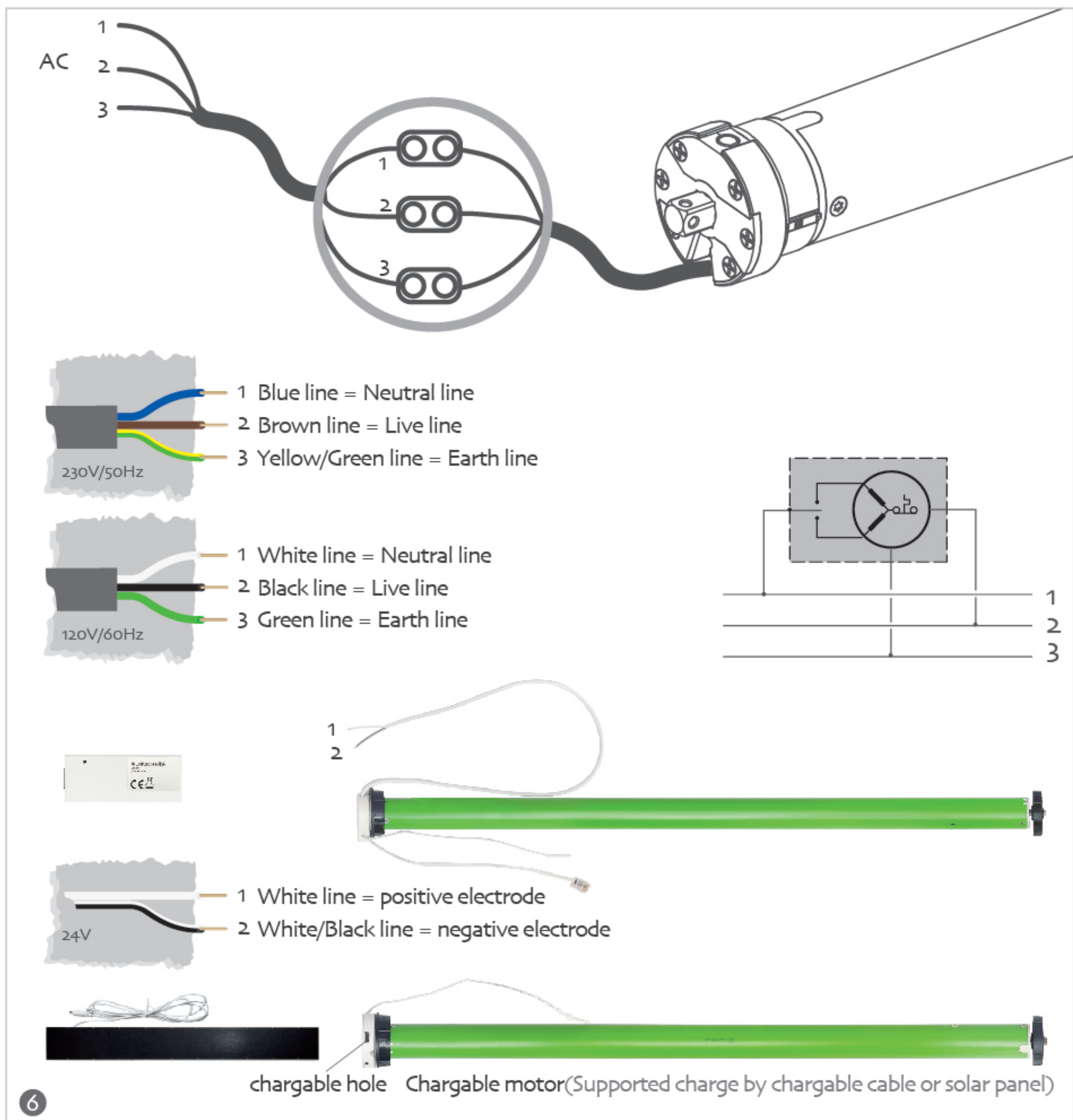

Step 6: Wire Connection

- (1) Confirm the Voltage. Currently we supply model is: 220-240V, 110-120V, 12/24V;
- (2) If in 220-240V as pic 6, the blue wire connect neutral line, Brown wire connect live line, yellow& green wire connect the earth line.
- (3) If in 110-120V as pic 6, white wire connect neutral line, black wire connect live line and green wire connect earth line.
- (4) If in 12/24V as pic 6, white wire connect positive electrode, white and black wire connect negative electrode.
- (5) If need connect with ZigBee or Tuya controller, then insert the registered jack into the relative controller mode.

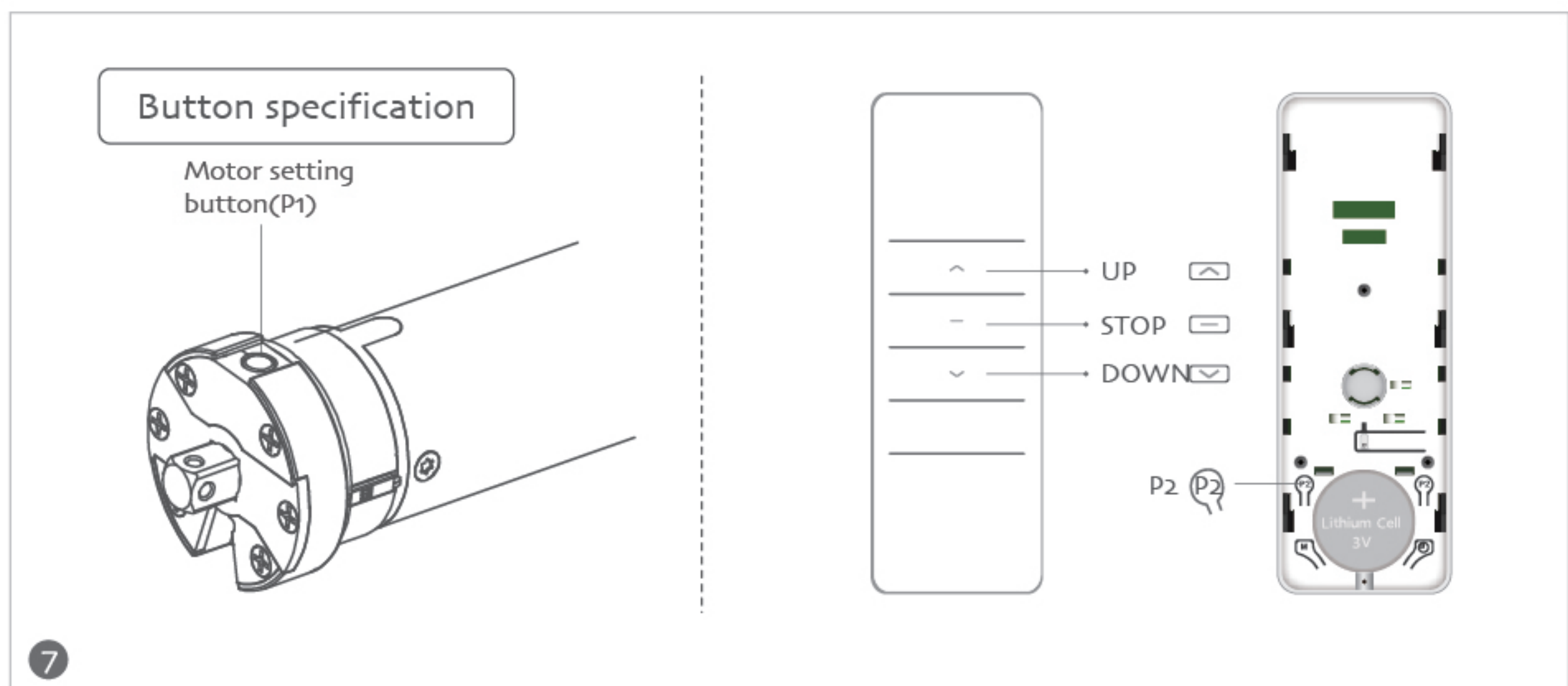

Step 7: Remote set

Remotes is paired as production, if need reset and pls operate as the below way or contact with service for more details.

(1) Setting up P2 → P2 → Up

If you want to change the direction of rotation, please do the reverse of direction setting (See the motor P1 button operation).

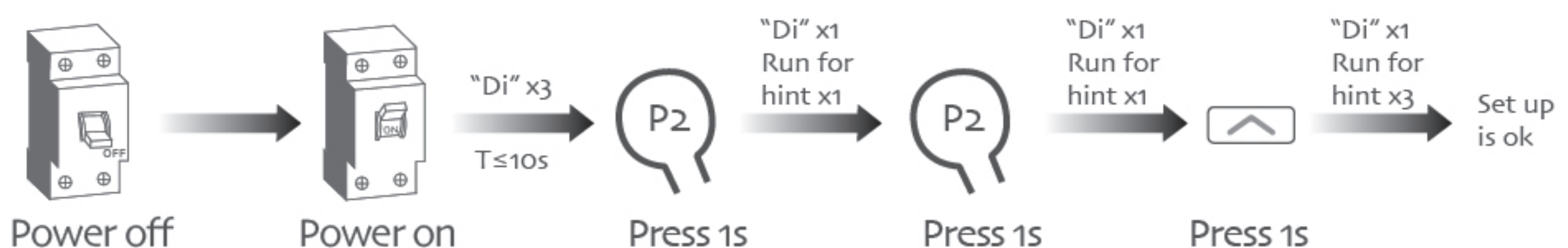

Note: Power down again on the electricity, no code when the motor "Di~" once, and the motor run for hint once.

(2)The reverse of direction setting (Up+ Down) x2s

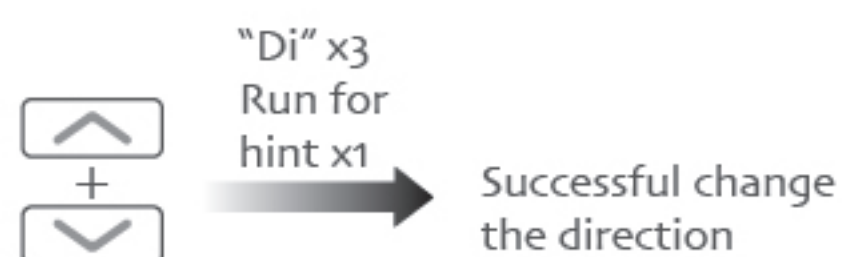

Press 2s

Note: This setting must be carried out without limit.

Step 8: Finish Installation.

Disassemble of Roller blinds

- Opposite operation with installation
- Use slotted screwdriver insert into the black spring shaft then it bounce back. the blinds loose then take the blinds off.

Cleaning

- Clean the surface of Aluminum frame parts with wet cloth.
- it could be clean with web cloth or brush to clean. If for soft fabric, advise to use small dust collector to clean the surface then ok.
- Pls no put the blinds into washing machine to clean.
- Pls no use chemical cleaner to clean the blinds such as bleach etc.

Fault and solution

Number	Phenomenon	Reason	Processing method
1	Motor can't running	a, The motor enters thermal protection. b, The emitter is not matched. c, If long press the set button, the motor still don't run, power short-circuit, circuit board bad or motor bad.	a, When motor is cooled b, Set up again c, Contact after-sales service

Integrity / Quality / Professional / Service



Tianjin Hunters Technology Co., Ltd

📍 No.6 building, Changqingteng Art & Industrial Park, No.10 Caizhi Road,
Jingwu town, Xiqing District, Tianjin, China. Post code: 300392

☎ +86 22 23982209

📱 +86 15922294041

✉ laura001@aliyun.com